

Touch sensing LED Introduction

2022/05/30

Greener and brighter

Touch sensing LED Advantages

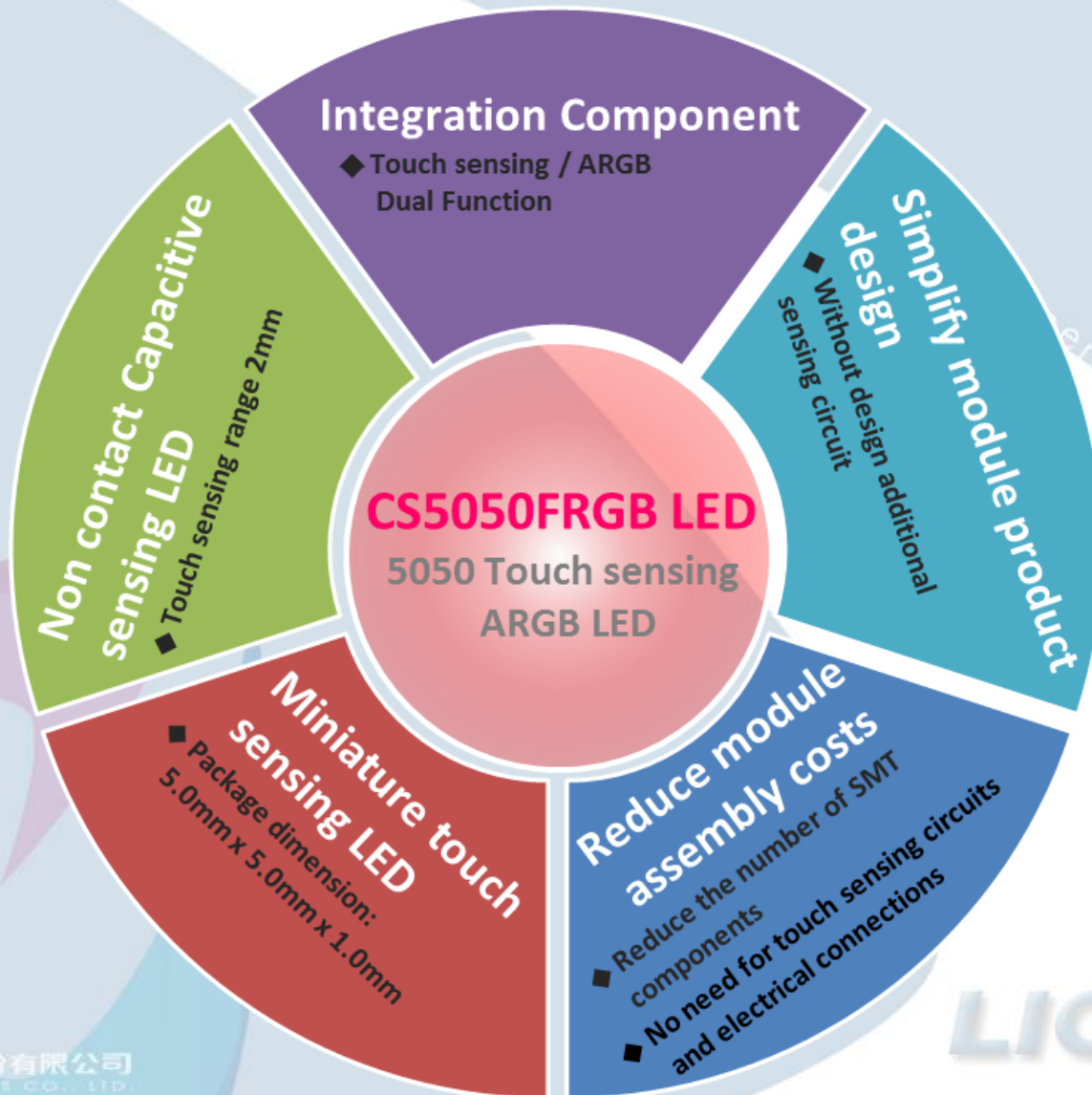

Touch sensing ARGB LED

Product advantage description

CS5050FRGB

Touch Sensing 5050ARGB LED

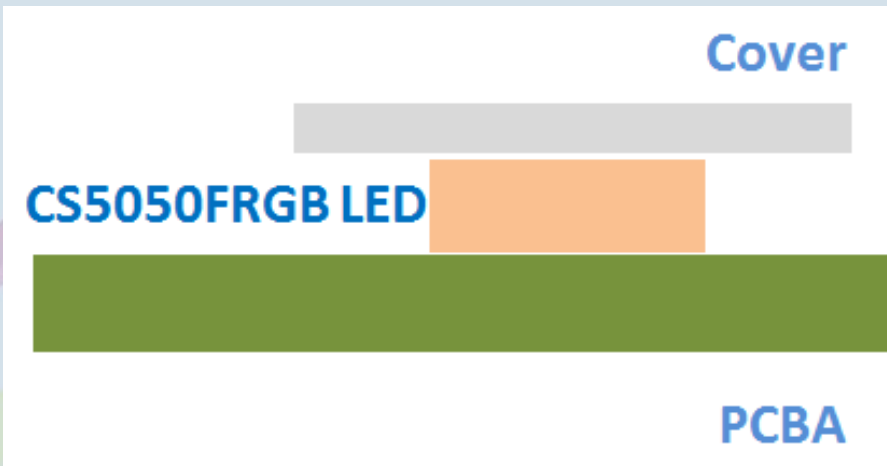

Normal Touch sensing Control
+ARGB LED

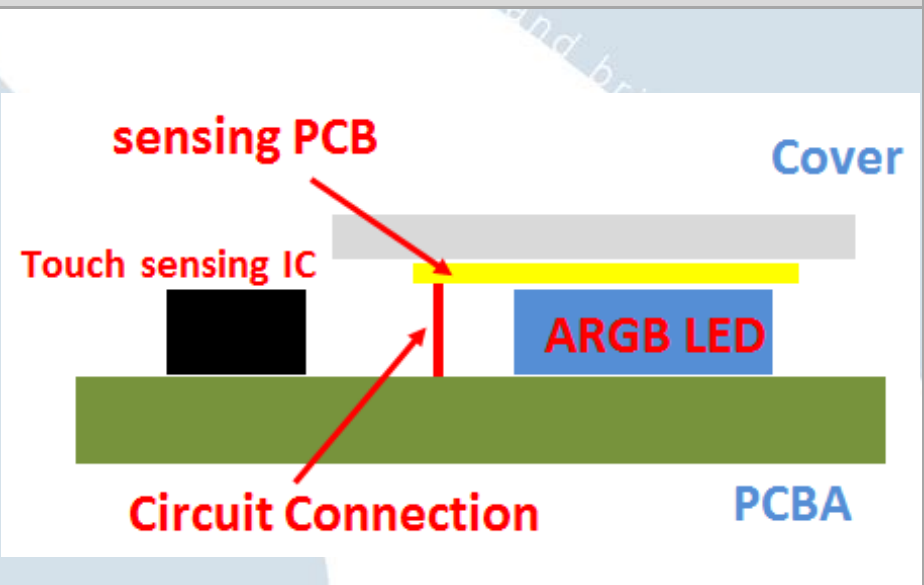

Touch sensing ARGB LED

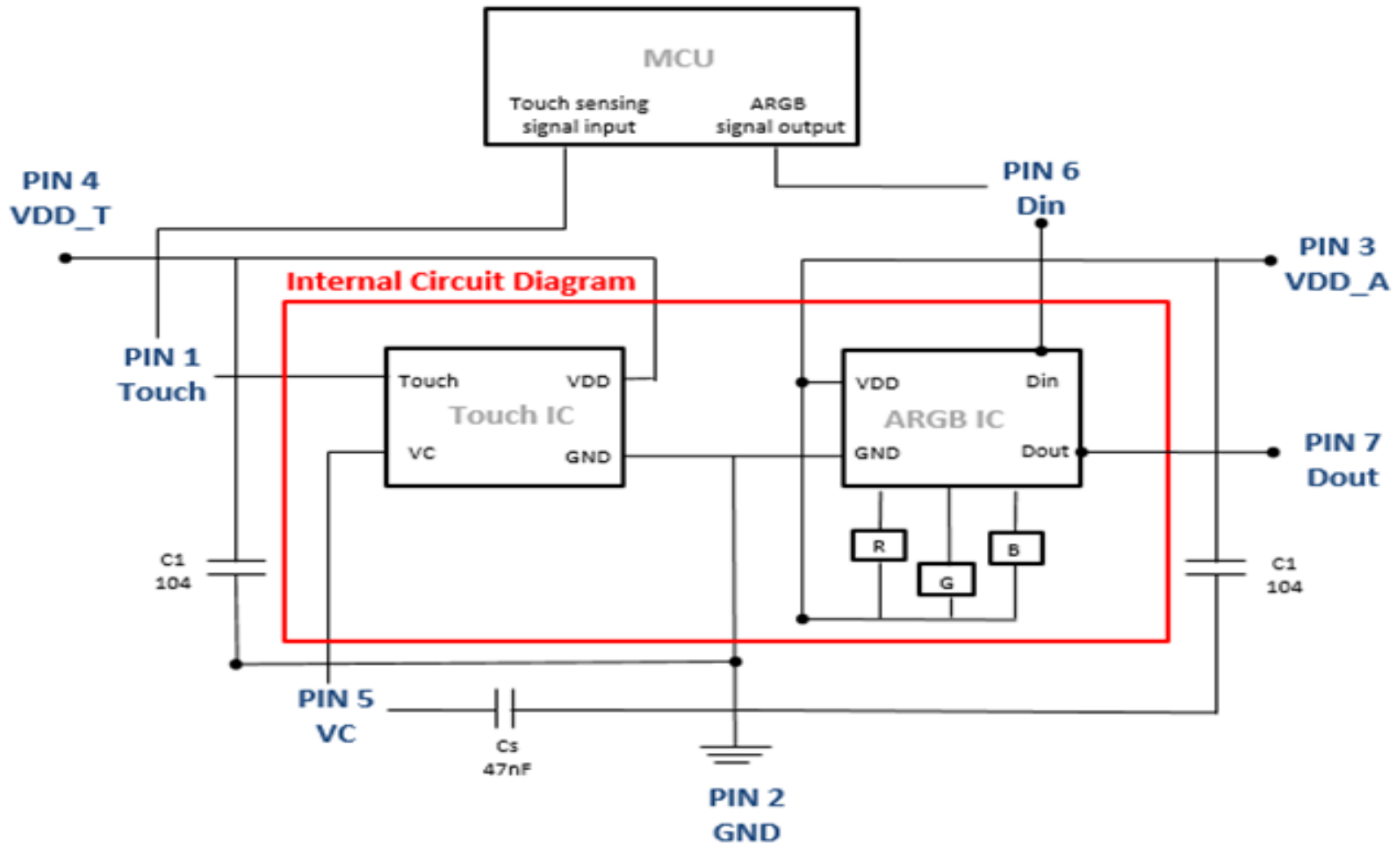

Control Circuit

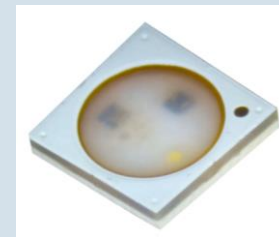

Touch sensing ARGB LED

Product Category



P/N		LG-CS5050FRGB	LG-CS5050FRGBW
Dimension		5.0mm x 5.0mm x 1.0mm	5.0mm x 5.0mm x 1.0mm
LED chip composition		R/G/B	R/G/B/W
Product Features	Touch IC	Sensing distance	2mm
		Sensitivity adjustable	1nF~47nF
	Driver IC	Constant current selection	5mA/12mA/20mA
		Total number of LED color	16,777,216
		Number of main colors	7 (R/G/B/RG/GB/BR/RGB) 
		Reading Number of Serially Connected Chips	support
		Current adjustable	support
		Configurable Refresh Rate	support
		Support parallel-connected multi-strip control mechanism	support
		power saving mode	support
		11 (R/G/B/RG/GB/BR/RGB/RW/GW/BW/W) 	

◆ Extra product for single color without driver IC type.

Applications

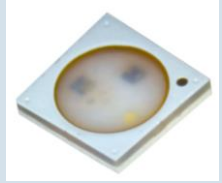

◆ Gaming



◆ major appliance



◆ Water purifier



◆ Automotive

